

# POWER RELAY

## 2 POLE—5 A (MEDIUM LOAD CONTROL)

### VB SERIES

RoHS compliant

#### FEATURES

- UL, CSA, VDE, SEV, SEMKO, CQC recognized TV-3 rated
- Working class: C
- UL class B (130°C) insulation
- Type of service: continuous duty
- Heavy duty miniature slim type power relay
- High isolation in standard package
  - Insulation distance: 8 mm
  - Dielectric strength: 5000 VAC (between coil and contacts)
  - Surge strength: 10000 V
- Standard and high sensitivity types available
- Flux free type and plastic sealed type available
- Lead Free since date code: 08B00034F - Please see page 8 for more information

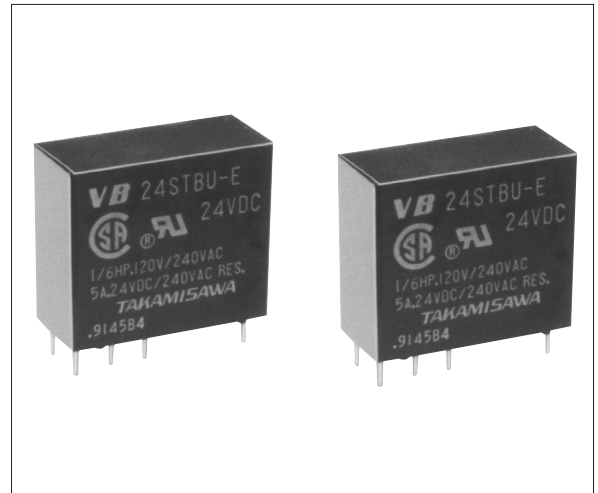

#### ORDERING INFORMATION

[Example] VB - 12 S M B U -

(a) (\*) (b) (c) (d) (e) (f) (\*) (g)

(a)	Series Name	VB: VB Series
(b)	Nominal Voltage	Refer to the COIL DATA CHART
(c)	Coil Type	Nil : Standard type (700-750 mW) S : High sensitive type (530 mW)
(d)	Contact Arrangement	M : 2 form A (DPST-NO) T : 2 form C (DPDT)
(e)	Enclosure	B : Flux free type C : Plastic sealed type (with tape) K : Plastic sealed type
(f)	Standard	Nil : TV-rating U : General (non TV-rating)
(g)	Contact Material	N : Silver alloy Nil : Silver cadmium oxide (TV-3 rating) 5 : Silver cadmium oxide (non TV-rating) Nil : Gold overlay silver-nickel (non TV-rating) E : Silver-nickel (non TV-rating)

Actual marking omits the hyphen (-) of (\*)

# VB SERIES

## COIL DATA CHART

TV-3 Rating		Standard	Nominal Coil resistance	Must operate	Must release	Nominal		
5A				voltage	(10%)	voltage	voltage	power
Standard Type	VB- 3M ( )	VB- 3 ( ) ( ) U-( )		3 V DC	12.5 Ω	2.1 VDC	0.3 VDC	0.72 W
	VB- 5M ( )	VB- 5 ( ) ( ) U-( )		5 V DC	36 Ω	3.5 VDC	0.5 VDC	0.70 W
	VB- 6M ( )	VB- 6 ( ) ( ) U-( )		6 V DC	50 Ω	4.2 VDC	0.6 VDC	0.72 W
	VB- 9M ( )	VB- 9 ( ) ( ) U-( )		9 V DC	115 Ω	6.3 VDC	0.9 VDC	0.70 W
	VB- 12M ( )	VB- 12 ( ) ( ) U-( )		12 V DC	200 Ω	8.4 VDC	1.2 VDC	0.72 W
	VB- 14M ( )	VB- 14 ( ) ( ) U-( )		14 V DC	280 Ω	9.8 VDC	1.4 VDC	0.70 W
	VB- 18M ( )	VB- 18 ( ) ( ) U-( )		18 V DC	460 Ω	12.6 VDC	1.8 VDC	0.70 W
	VB- 24M ( )	VB- 24 ( ) ( ) U-( )		24 V DC	820 Ω	16.8 VDC	2.4 VDC	0.70 W
	VB- 36M ( )	VB- 36 ( ) ( ) U-( )		36 V DC	1,850 Ω	25.2 VDC	3.6 VDC	0.70 W
	VB- 48M ( )	VB- 48 ( ) ( ) U-( )		48 V DC	3,300 Ω	33.6 VDC	4.8 VDC	0.70 W
	VB- 60M ( )	VB- 60 ( ) ( ) U-( )		60 V DC	5,100 Ω	42.0 VDC	6.0 VDC	0.70 W
VB-100M ( )	VB- 100 ( ) ( ) U-( )		100 V DC	13,400 Ω	70.0 VDC	10.0 VDC	0.75 W	
High Sensitivity Type		VB- 3S ( ) ( ) U-( )		3 V DC	17 Ω	2.1 VDC	0.3 VDC	0.53 W
		VB- 5S ( ) ( ) U-( )		5 V DC	47 Ω	3.5 VDC	0.5 VDC	0.53 W
		VB- 6S ( ) ( ) U-( )		6 V DC	68 Ω	4.2 VDC	0.6 VDC	0.53 W
		VB- 9S ( ) ( ) U-( )		9 V DC	155 Ω	6.3 VDC	0.9 VDC	0.53 W
		VB-12S ( ) ( ) U-( )		12 V DC	270 Ω	8.4 VDC	1.2 VDC	0.53 W
		VB-14S ( ) ( ) U-( )		14 V DC	370 Ω	9.8 VDC	1.4 VDC	0.53 W
		VB-18S ( ) ( ) U-( )		18 V DC	600 Ω	12.6 VDC	1.8 VDC	0.53 W
		VB-24S ( ) ( ) U-( )		24 V DC	1,100 Ω	16.8 VDC	2.4 VDC	0.53 W
		VB-36S ( ) ( ) U-( )		36 V DC	2,450 Ω	25.2 VDC	3.6 VDC	0.53 W
		VB-48S ( ) ( ) U-( )		48 V DC	4,400 Ω	33.6 VDC	4.8 VDC	0.53 W
		VB-60S ( ) ( ) U-( )		60 V DC	6,800 Ω	42.0 VDC	6.0 VDC	0.53 W
		VB-100S ( ) ( ) U-( )		100 V DC	18,860 Ω	70.0 VDC	10.0 VDC	0.53 W

Note: All values in the table are measured at 20 °C.

# VB SERIES

## ■ SPECIFICATIONS

Item		TV-3 Rating		Standard Type		
		VB-( ) M	VB-( ) M-N	VB-( ) U-5	VB-( ) U-N	VB-( ) U VB-( )-E
Contact	Arrangement	2 form A (DPST-NO)		2 form A (DPST-NO) or 2 form C (DPDT)		
	Material	Silver-cadmium oxide	Silver-alloy	Silver-cadmium oxide	Silver-alloy	Gold overlay silver-nickel (non gold overlay only VB-E)
	Style	Single				
	Resistance (initial) (1 A 24 VDC)	Maximum 100 mΩ				
	Rating (resistive)	5 A 240 VAC/24 VDC				
	Maximum Closing Current	7 A				
	Maximum Switching Power	1,200 VA, 120 W				
	Maximum Switching Voltage	250 VAC, 150 VDC				
	Maximum Switching Current	5 A				
	Minimum Switching Load	100 mA 5 VDC (VB-M, 5, E) 10 mA 5 VDC (VB-)				
	Maximum Inrush Current	5 A 120 VAC (at lamp load)	—			
Coil	Nominal Power (at 20°C)	Standard type: 700 to 750mW, high sensitivity type: 530mW				
	Operate Power (at 20°C)	Standard type: 350 to 370mW, high sensitivity type: 260mW				
	Operating Temperature	Standard type: -40°C to +65°C, high sensitivity type: -40°C to +75°C (no frost)				
Time Value	Operate (at nominal voltage)	Maximum 5 ms				
	Release (at nominal voltage)	Maximum 10 ms				
Life	Mechanical	2 × 10 <sup>7</sup> operations minimum				
	Electrical	1 × 10 <sup>5</sup> operations minimum at rated load				
		5 × 10 <sup>4</sup> operations minimum at motor load (1/8HP 120 VAC)	3 × 10 <sup>4</sup> operations minimum at motor load (1/8HP 120 VAC)			
	5 × 10 <sup>4</sup> operations minimum at lamp load	—				
Other	Vibration Resistance	Misoperation	10 to 55 Hz (double amplitude of 1.5 mm)			
		Endurance	10 to 55 Hz (double amplitude of 1.5 mm)			
	Shock Resistance	Misoperation	100 m/s <sup>2</sup> (11 ± 1 ms)			
		Endurance	1,000 m/s <sup>2</sup> (6 ± 1 ms)			
	Weight	Approximately 17 g				

\*1 Minimum switching loads mentioned above are reference values. Please perform the confirmation test with the actual load before production since reference values may vary according to switching frequencies, environmental conditions and expected reliability levels.

\*2 IMQ 

\*3 IMQ 

**■ SAFETY STANDARDS**

Type	Compliance	Contact rating
UL	UL 508, 873 E56140	Flammability: UL 94-V0 (plastics) TV-rating 5A, 240VAC/24VDC (resistive) 1/6 HP, 240VAC/120VAC Pilot duty: C150 TV-3 120VAC
CSA	C22.2 No. 14 LR 35579	
VDE	0435, 0531, 0700, 0860	5A, 240VAC/24VDC (resistive) 1/6 HP, 240VAC/120VAC Pilot duty: C150

Complies with SEV, SEMK, CQC, VDE

**■ INSULATION**

Item		Note
Resistance (initial)	Minimum 1000 M $\Omega$	at 500 VDC
Dielectric Strength	open contacts	1,000 VAC (50/60 Hz) 1 min.
	coil and contacts adjacent contact	5,000 VAC 1 min., 10,000 VAC 1 min.
Surge Voltage (coil and contact)	10,000 V (6,000V adjacent contact)	1.2 x 50 $\mu$ s standard wave

**■ CHARACTERISTIC DATA**

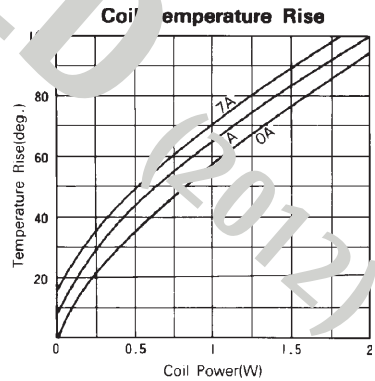
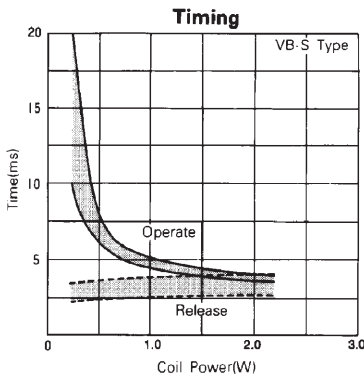
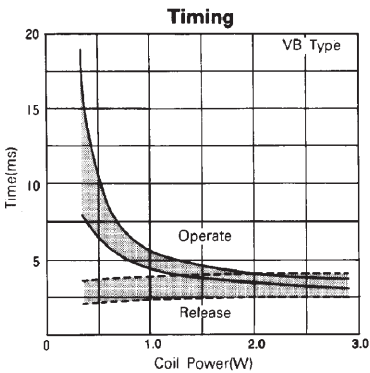

# VB SERIES

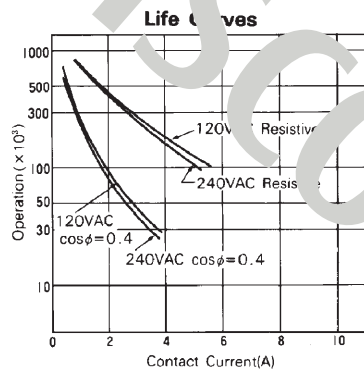
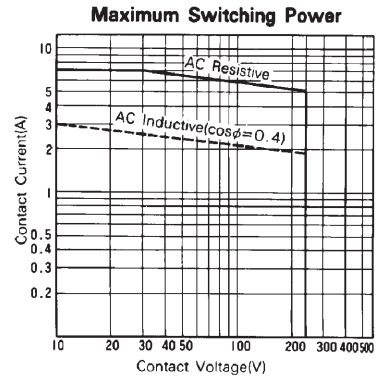
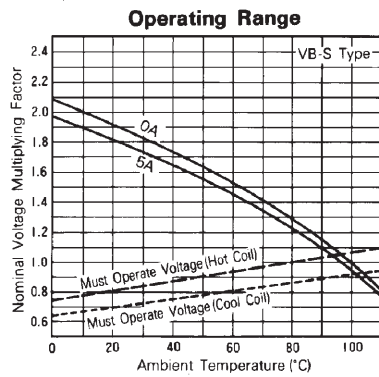
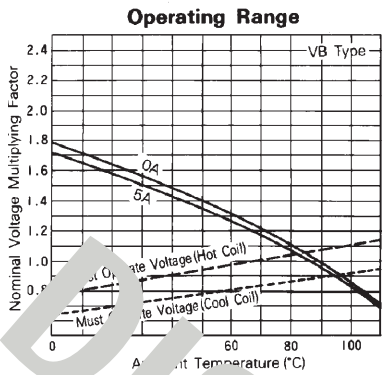

## REFERENCE DATA

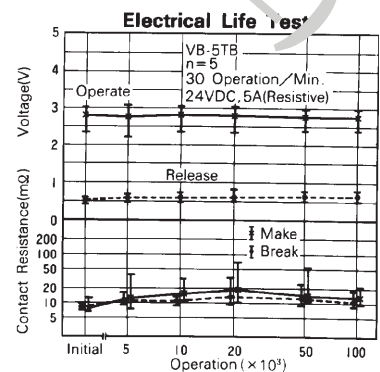
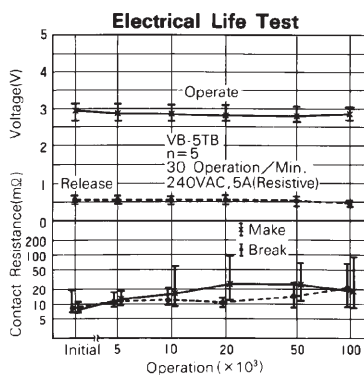
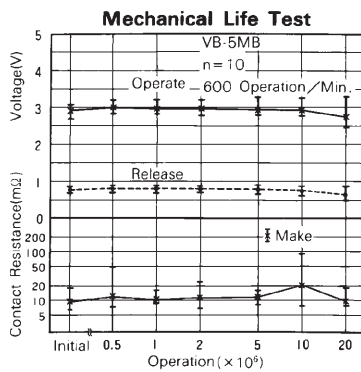
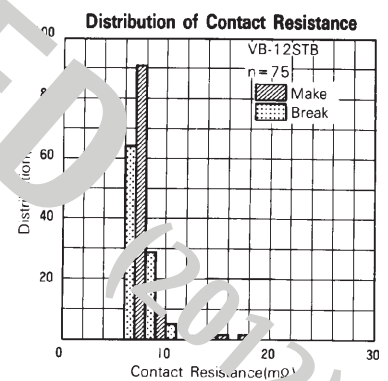
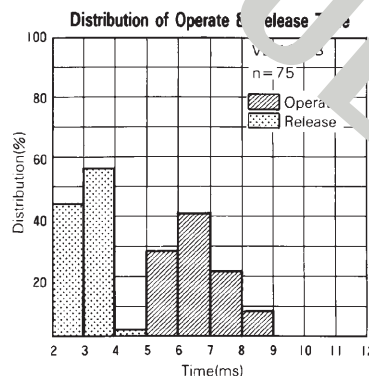
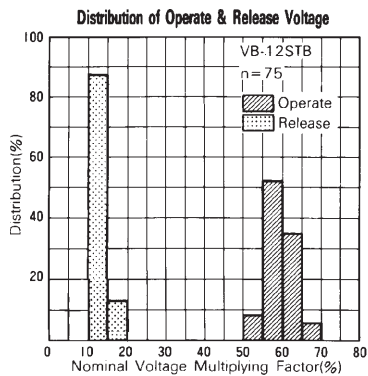



# VB SERIES

VB-MC type (Plastic sealed type with tape)

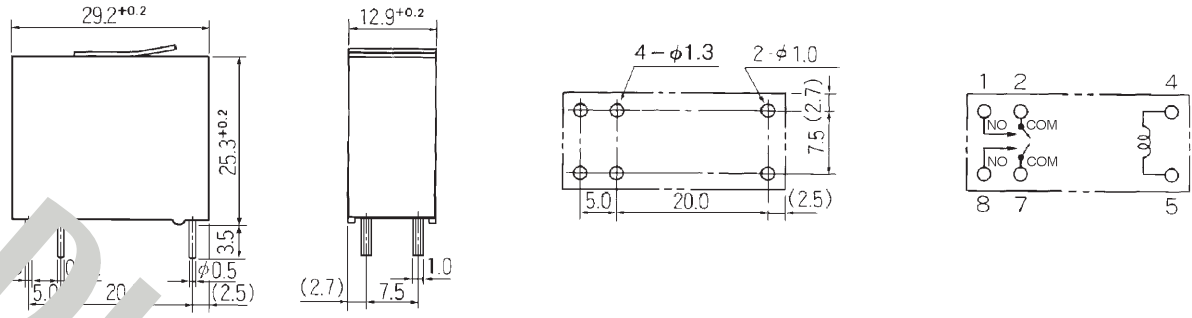

VB-C type (Plastic sealed type with tape)

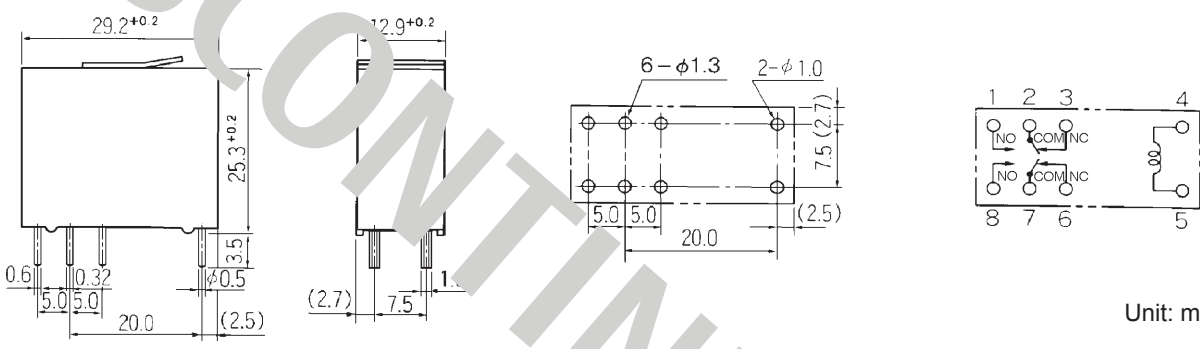

Unit: mm

DISCONTINUED (2012)

## RoHS Compliance and Lead Free Relay Information

### 1. General Information

- Relays produced after the specific date code that is indicated on each data sheet are lead-free now. All of our signal and power relays are lead-free. Please refer to Lead-Free Status Info. (<http://www.fujitsu.com/us/downloads/MICRO/fcai/relays/lead-free-letter.pdf>)
  - Lead free solder paste currently used in relays is Sn-3.0Ag-0.5Cu.
  - All signal and power relays also comply with RoHS. Please refer to individual data sheets. Relays that are RoHS compliant do not contain the 5 hazardous materials that are restricted by RoHS directive (lead, mercury, chromium IV, PBB, PBDE).
  - It has been verified that using lead-free relays in leaded assembly process will not cause any problems (compatible).
  - "LF" is marked on each outer and inner carton. (No marking on individual relays).
  - To avoid leaded relays (for lead-free sample, etc.) please consult with area sales office.
  - We will ship leaded relays as long as the leaded relay inventory exists.
- Note: Cadmium was exempted from RoHS on October 21, 2005. (Amendment to Directive 2002/95/EC)

### 2. Recommended Lead Free Solder Profile

- Recommended solder paste Sn-3.0Ag-0.5Cu.

#### Reflow Solder condition

**Flow Solder condition:**

Pre-heating: maximum 120°C  
Soldering: dip within 5 sec. at  
260°C solder bath

**Solder by Soldering Iron:**

Soldering Iron  
Temperature: maximum 360°C  
Duration: maximum 3 sec.

**We highly recommend that you confirm your actual solder conditions**

### 3. Moisture Sensitivity

- Moisture Sensitivity Level standard is not applicable to electromechanical relays.

### 4. Tin Whisker

- Dipped SnAgCu solder is known as low risk tin whisker. No considerable length whisker was found by our in house test.



## Fujitsu Components International Headquarter Offices

### Japan

Fujitsu Component Limited  
Gotanda-Chuo Building  
3-5, Higashigotanda 2-chome, Shinagawa-ku  
Tokyo 141, Japan  
Tel: (81-3) 5449-7010  
Fax: (81-3) 5449-2626  
Email: [info@ft.ed.fujitsu.com](mailto:info@ft.ed.fujitsu.com)  
Web: [www.fcl.fujitsu.com](http://www.fcl.fujitsu.com)

### North and South America

Fujitsu Components America, Inc.  
250 E. Caribbean Drive  
Sunnyvale, CA 94089 U.S.A.  
Tel: (1-408) 745-4900  
Fax: (1-408) 745-1970  
Email: [components@fujitsu.com](mailto:components@fujitsu.com)  
Web: <http://www.fujitsu.com/services/edevice/components/>

### Europe

Fujitsu Components Europe B.V.  
Diamantlaan 25  
2132 WV Hoofddorp  
Netherlands  
Tel: (31-23) 5560910  
Fax: (31-23) 5560950  
Email: [info@fceu.fujitsu.com](mailto:info@fceu.fujitsu.com)  
Web: [emea.fujitsu.com/components/](http://emea.fujitsu.com/components/)

### Asia Pacific

Fujitsu Components Asia Ltd.  
102E Pasir Panjang Road  
#01-01 Citilink Warehouse Complex  
Singapore 118529  
Tel: (65) 6375-8560  
Fax: (65) 6273-3021  
Email: [fcsl@fcal.fujitsu.com](mailto:fcsl@fcal.fujitsu.com)  
Web: <http://www.fujitsu.com/sg/services/micro/components/>

©2007 Fujitsu Components America, Inc. All rights reserved. All trademarks or registered trademarks are the property of their respective owners.

Fujitsu Components America or its affiliates do not warrant that the content of datasheet is error free. In a continuing effort to improve our products Fujitsu Components America, Inc. or its affiliates reserve the right to change specifications/datasheets without prior notice.  
Rev. November 30, 2007